

# Senior Laboratory

PHYS 493L, Spring 2024

**Lab Time:** Tuesdays & Thursdays, 8am-10:50am

**Lectures:** most Tuesdays (PAIS 1405)

**Lab Location:** PAIS 1417

**Instructor:** Tara Drake

Email: [drakete@unm.edu](mailto:drakete@unm.edu)

Offices: PAIS 2234 and CHTM 118B

**Teaching Assistant:** Ameen Zerrad

Email: [azerrad151@unm.edu](mailto:azerrad151@unm.edu)

**Office Hours:** arrange meeting with instructor or TA via email

# Senior Lab 493L

## Overview

Lab course: experiments in particle physics and atomic molecular and optics (AMO) for advanced undergraduates. Students will perform experiments related to:

- Quantization and Wave-particle duality
- Nuclear decay, lifetime measurements, and particle physics
- Photon and coincidence counting
- Atomic structure and laser physics
- Interferometry and metrology

## Goals

- Develop independent problem-solving and experiment planning and execution
- Strengthen facility with research laboratory equipment and techniques
- Learn/practice effective technical writing and oral presentation skills

# Senior Lab 493L

## Course Structure

- Current enrollment: 5
- Work one student per experiment
- Each student completes 4 experimental modules from 6 available
- Oral presentation (lecture for classmates)
- Homework

# Experimental modules

**4 modules required**

**7 sessions per experiment**

**Report due 1 week after**

- **Nuclear physics**
- **Wavemeter**
- **Single photon interference**
- **Laser velocimetry**
- **Lock-In Amplifier**
- **Saturated Absorption Spectroscopy**

# Nuclear physics

- Spectroscopy of gamma rays from radioactive material
- Muon decay

## Gamma ray spectroscopy

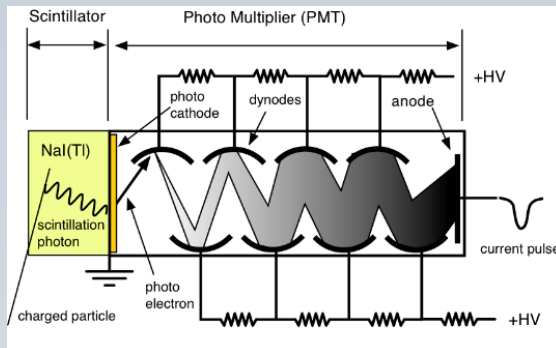
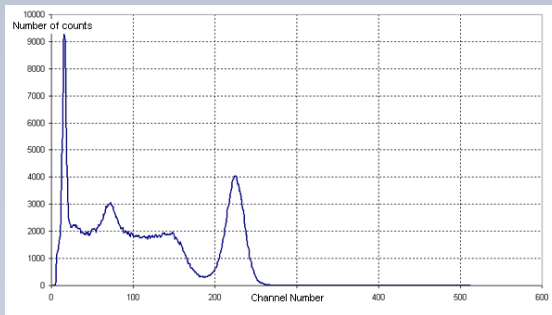

## Muon decay: Weak interactions

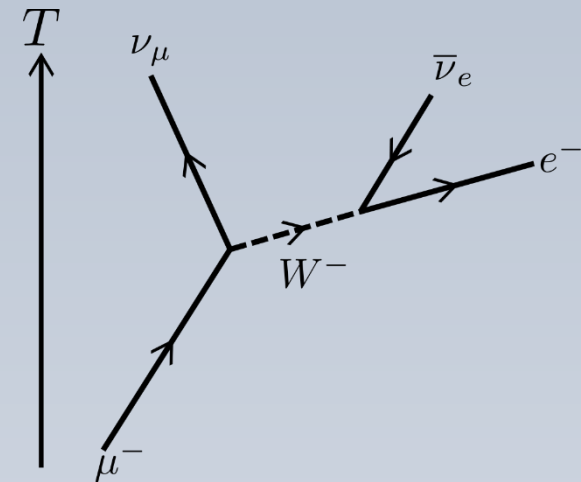

The muon a [constituent](#) of [cosmic-ray](#) particle “showers”. 1936 [Carl D. A.](#) and S. Neddermeyer.

$$\mu^+ \rightarrow e^+ \nu_e \bar{\nu}_\mu$$

$$\mu^- \rightarrow e^- \bar{\nu}_e \nu_\mu$$

# Wavemeter

- Using a known reference laser
- Measure the wavelength of a second laser using interference
  - Beam alignment; interferometry; stability; calibration and nonlinear effects correction for frequency metrology

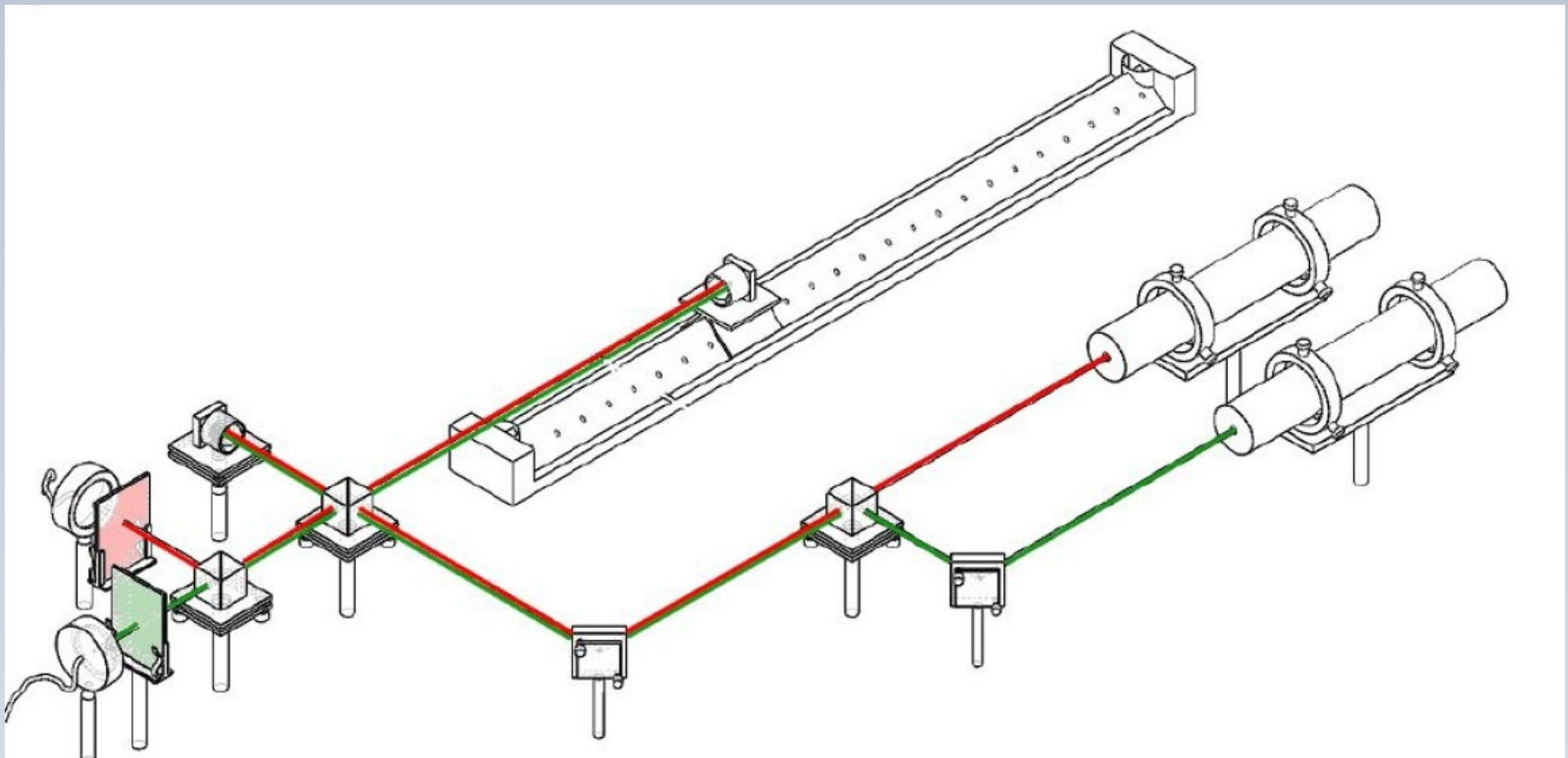

# Single photon interference

## Concepts:

- Wave particle duality
- Photon flux
- Calibration
- Photon counting
- Diffraction of particles

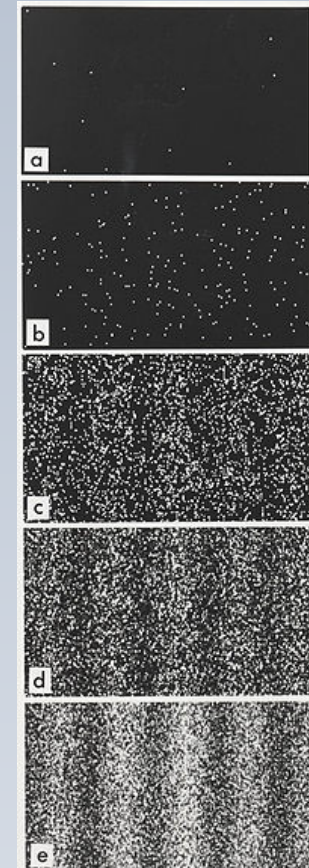
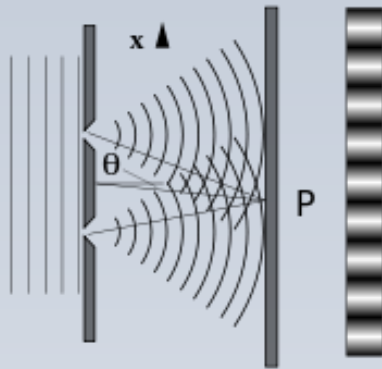

# Laser velocimetry

- Interference and light shifts

## Concepts:

- Doppler shift
- Optical arrangement
- Interferometry
- Optical pathlength calculations
- Frequency mod. detection techniques

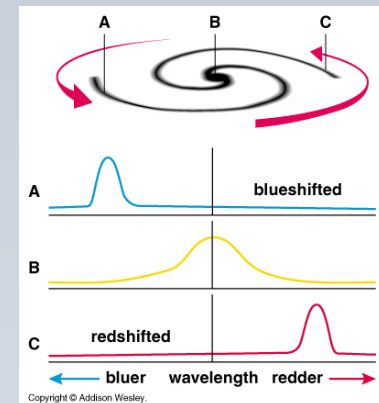



# Lock-in Amplifier

- Detection of ultra weak signals  $\ll$  background
- Develop experiment to implement locking detection

Lock in amplification is a coherent detection technique that is very useful in experimental physics.

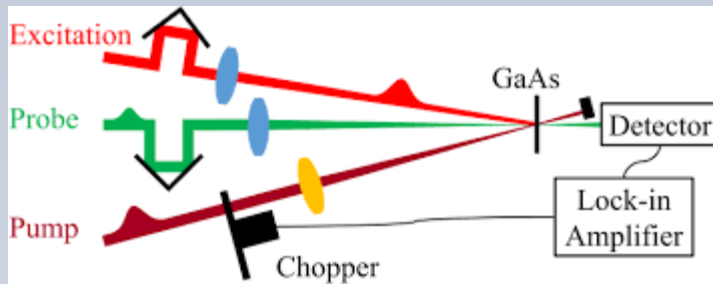

Observation of Nondegenerate Two-Photon Gain in GaAs. [PhysRevLett.117.073602](#)



ROBERT H. DICKE

# Saturated Absorption Spectroscopy

- Sensitive laser absorption spectroscopy in Rb atoms

## Concepts:

- External cavity diode laser
- Atomic quantization
- Spin-orbit coupling
- Hyperfine interactions in atoms
- Interferometry as a frequency reference

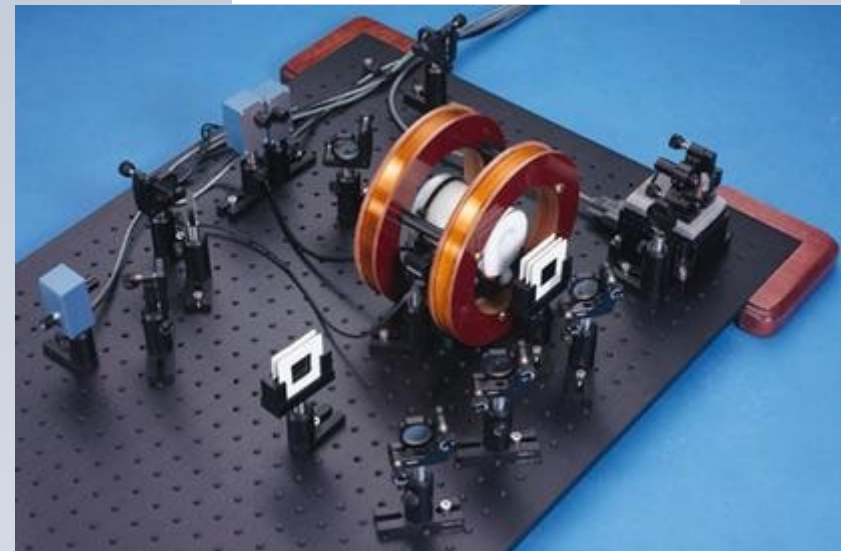
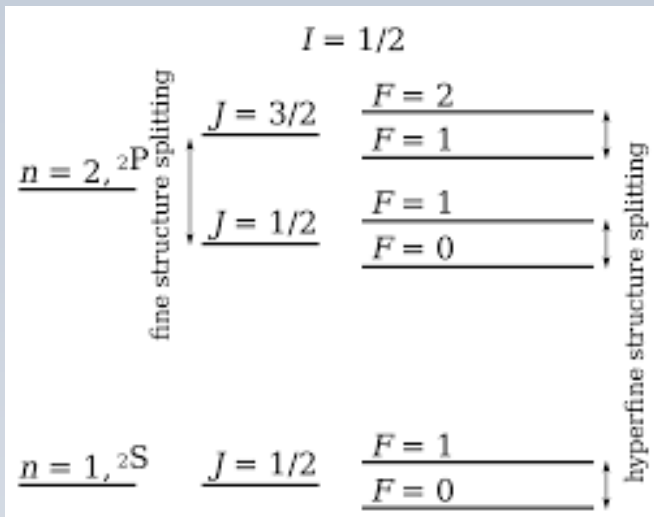
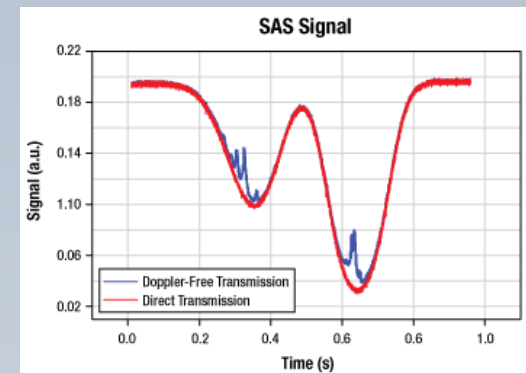

# Class Participation

Lab notebooks will count towards participation.

Attendance will also count towards participation. Discuss any *expected* absences with me ASAP. (Including prospective graduate school visits.)

**However**, attendance with COVID symptoms, exposure to someone with COVID, or a positive COVID test is prohibited. Be cautious and upfront about possible infection, and I will find a way for you to catch up.

# Lab Notebook

- **Each student maintains an Electronic Lab Notebook (google docs)**
- All students are expected to bring a laptop to each class. (See me with any problems.)
- At the beginning of every experiment, each student will begin a Google Doc to serve as lab notebook for that experiment and share it with **drakete@unm.edu** and **azerrad151@unm.edu**.
- The lab notebook should be detailed, clear, complete, and updated every class. You will be graded on the completeness and clarity of your notes-- **using your lab notebook, a third party should be able to reproduce your work.**
- The instructors will look at your lab notebook each week to gauge your preparedness and progress; this will count towards your class participation grade.

# Lab Notebook Format

- At the beginning of every experiment, each student will begin a Google Doc to serve as lab notebook for that experiment and share it with **drakete@unm.edu** and **sorensonj@unm.edu**.
- Sections of a lab notebook, for each separate experiment:
  - Before starting a new experiment: **Experimental Plan**
  - **New entry for every day in lab**

# Lab Notebook: Planning the experiment

Prior to beginning a new experiment, you will have read all the way through the manual and decided:

- What tasks must be completed on which days to finish the experiment in the time allotted?
- What data will you be taking for your report (and when)?
- Do you have any questions about the experiment or the physics involved?
- What equipment will you need to start?

# Lab Notebook: Daily log

- **Name, Date (for each new day)**
- **Objective:** Your goal(s) for the day
- **Plan:** How you will reach the day's objectives. Your plan of attack.
- **Expected results/hypothesis:** This is a clear if/then statement that defines the independent variables (your inputs, what you will do/change), the dependent variables (your outputs), and what you expect to learn.
- **Methods:** Plan out your work. Explain any procedures. What equipment do you need?
- **Results:** Your data (or a link) and results
  - This should include difficulties, how you solved them, and anything that went wrong, as well as what went right.
- **Analysis:** Beyond the data that you present above, this is how you interpret and understand the data. A plot that aggregates and compares your analyzed results is good.
- **Conclusions:** What you accomplished and what you learned.
- **Reflections and next steps:** What will you do next? Were there any interesting or unexpected things you came across? Are you concerned that you should go back and check the validity of some step? Do you see a potential problem on the horizon?

Use **figures, photos, drawings, detailed descriptions of setup**, etc.

Include important information such as **experimental parameters**, etc.

\*Remember: A lab notebook is a legal document recording your work and discoveries.

# Lab Reports

Each student produces a separate formal report based on experiment.  
Should follow the style of a scientific journal (Typed, one or two columns)

- **Main sections (see guide in class website for specific details)**
  - **Abstract:** concise description of methods and results.
  - **Introduction:** motivation, background and summary of experiment
  - **Methods:** description of experimental methods and calibrations
  - **Data:** present the data, use plots or/and tables
  - **Results and data analysis:** describe how the data analysis was done and present your results with errors
  - **Discussion**
  - **Conclusion**
  - **References**
  - **Appendix if necessary**

- **Purpose**
  - Gain familiarity with formal writing style of scientific journals

→ Document with guidelines available on class website. (also in a future lecture)

## Phys. Rev. Lett.

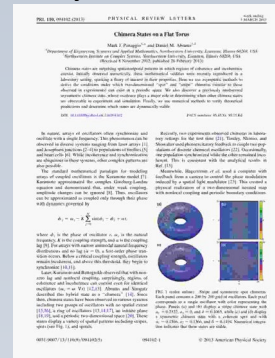

## Opt. Lett.





# Oral Presentation

Prepare and present a **30-50 minute lesson** based on an important concept and/or technique used in this class.

## Purpose

- Strengthen your understanding of an important concept
- Strengthen your communication and presentation skills
- Think how to present a laboratory technique/science to a broad audience

Topics will be chosen by me.

Topics will relate directly to Senior Lab experiments. You may choose to use your data/results in your lecture, but this is not required.

A practice lecture with me during a Monday lecture slot is required.

In addition to the lecture, you will prepare a short homework assignment for your classmates based on your lecture. (due 1 week before lecture)

# Homework

- **Some lectures will come with homework (error analysis, for example).**
  - Due 1 week after lecture (or at the end of lecture, if appropriate).
  - These are short assessments to gauge understanding of material.
  - You will also be responsible for writing one homework assignment for your classmates.

# Grading

## Schedule (subject to revision)

Date	Description
02/15 (R)	1st Lab Report due
03/19 (T)	2nd Lab Report due
04/11 (R)	3rd Lab Report due
05/07 (T)	4th Lab Report due

Class Participation + Lab Notebook	15%
4 Formal Reports (15% each)	60%
Homework	10%
Presentation	15%
<b>Total</b>	<b>100%</b>

***Late work policy:*** Late reports will be marked down one full letter grade for each class that passes after report is due.

*In some cases, it may be possible to resubmit a report with revisions for more credit.*

**Please check course website for updates (on [physics.unm.edu](http://physics.unm.edu))**

# Lab Safety, General

- **Footwear.**- Closed-toed shoes with a low, covered heel.
- **Electrical.**- Some experiments use HV supplies. Look for damaged cables or faulty connections.
- **No food or drinks.**- Do not eat or drink in the laboratory. Any spill can cause irreversible damage to equipment and can cause an accident when working with or near HV equipment.\*
- **Broken or nonworking equipment.**- Report any nonfunctioning equipment to the lab instructor or the TA.
- **Secure room.**- Close the door behind you when you leave or you go out of the laboratory for a short period of time.

\* I encourage you to bring bottled water and keep it in the provided cubbies. Snacks and water can be taken outside to eat.

# Lab Safety, general continued

- **Broken glass.**- Do not deposit chipped or broken glass in normal trash containers. Use a glass bin.
- **No loose ends.**- Tie your shoelaces and long hair must be tied back.
- **House keeping.**- Clean up and make sure everything is safe before you leave. Keep your work area in order. Do not block passages or exits with cables or equipment.
- **Report any accident or concern to the instructor or TA.**
- **Before doing an experiment.**- Talk to the instructor or TA about the safety concerns of each experiment and any special instructions for working with sensitive equipment.
- **Use caution when handling radioactive material.** In most cases, only instructor or TA will handle.

# Laser Safety

- **Training:** Complete laser safety training module on <https://learningcentral.unm.edu/>, “Laser Safety Training, UNM PandA”, and send me evidence of completion.
- **Read laser specifications.**
- **Use laser-safety glasses.** (Provided with each laser experiment—get help to find some if not. Goggles will be disinfected before and after each class and will be available at the front of the room.)
- **Practice care, communication, and common sense:**
  - Most laser accidents occur during alignment, and many NOT to those aligning.
  - When laser is on, curtains are closed. (Otherwise, communicate to the room, distribute eyewear, and hang notes on doors.)
  - Remove jewelry and watches on hands, hanging necklaces, and anything else potentially reflective. Keep cell phones off lab tables and away from beam paths.

# Today

- Email me a list of at least 4 experiments you would like to do. You can rank by order of preference.
- Complete laser safety training (learning central).
- Start a new google doc lab notebook and share it with me.
- Read the experiment manual and plan your work for the next module (in lab notebook).

